

DRIVELINE SERVICES

â |] ~ [ââ-âll { ~ çllä ~ æ

RXcZTf]ef cR]171ae`1TReR]`XfV

dVTeZ`_1K1J

aRXVl>1z

TABLE OF CONTENTS

dvtz, €1K1J

â\$-i!èö!-dèMÔM { ~ |

ers)vl`wIT, €iv€††

Uv†, †

{ 8 f ~-M [dôiè\$=
ä8 è...è"ø" M] `d:ô=
} !i†ém ["è" d="Mç8é"=MRM]...èiè"°
{ iè†`M`8èøMç8é"=MRM]...èiè"°
{ èdièM`8-"Mç8é"=MRM`d....."°M:-8-M="øM=†-" f
{ iè†`M`8èøMç8é"=MRM { èdièM†8-"
] `d:ô:èè\$MÔM`!†iè\$

^vtyr€z††

i èi j ~-dèM*8ièøMæi è"è=i8èdèMædòd
{ èdièM`8-"Mç8é"=MRM`d....."°M:-8-M="øM=†-" f
{ iè†`M`8èøMç8é"=MRM]...èiè"°
} !i†ém ["è" d="Mç8é"=MRM]...èiè"°
]...èiè"°Mç8é"=MRM`d....."°M:-8-M="øM=†-" f
]...`†ièMç8é"=
æ8!†è" M { i j 8èøMç8é"=
&èdè\$`Mç8é"=
] èi...Mç8é"=
c`è"°Mç8é"=
æ-i j`M`i†=
] èi...MÔM] ø!†Mâ=="è†èi"=
i è f`è"°"øMæ-i j`"d:ô=
@`5=
]`øM] †-" f =

arxv1z

arxv1B > arxv1BA

{ d\$`Mß
{ d\$`MU
{ d\$`MÚ
{ d\$`MÛ
{ d\$`MÜ
{ d\$`MÛ
{ d\$`MV R { d\$`MßT

arxv1BB > arxv1CJ

{ d\$`Mßß
{ d\$`MßU R { d\$`MßÛ
{ d\$`MßÜ
{ d\$`MßÙ R { d\$`MßV
{ d\$`MßW
{ d\$`MßX
{ d\$`MUT
{ d\$`MUP
{ d\$`MUU
{ d\$`MUÚ R { d\$`MUÛ
{ d\$`MUÜ
{ d\$`MUÙ
{ d\$`MUV
{ d\$`MUW
{ d\$`MUX

M

*!è\$MUTTU

AGRICULTURAL

Polythene covered drive shaft

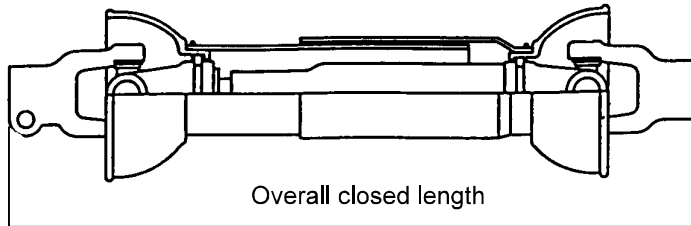

Attention: Universals must be greased every 50 hours use.
Drive shaft telescopic slide to be greased daily.

Power Ratings

Drive Shafts @ 550 r.p.m kw (HP)

SHAFT SELECTIONS

CONDITIONS OF DRIVE	SERIES							REMARKS
	1AG	2AG	3AG	4AG	5AG	7AG	8AG	
Very Severe	11 (15)	12 (16)	16 (22)	16 (22)	34 (46)	34 (46)	41 (55)	Heavy shock loading and where high angle is encountered.
Average	15 (20)	16 (22)	22 (30)	22 (30)	46 (62)	46 (62)	55 (74)	Occasional shock loading and where working angle does not exceed 20 degrees.
Ideal	24 (32)	26 (35)	36 (48)	36 (48)	72 (97)	72 (97)	88 (118)	Smooth running without shock loading and where working angle does not exceed 5 degrees.
Maximum intermittent angle	30	40	40	40	40	40	40	
Maximum continuous angle	20	20	20	20	20	20	20	
Method of calculating torque and power	Torque (Nm) = $\frac{\text{kW} \times 9555}{\text{r.p.m}}$ Power (kW) = $\frac{\text{torque} \times \text{r.p.m}}{9555}$ Torque (lbf in) = $\frac{\text{HP} \times 63025}{\text{r.p.m}}$ Power (HP) = $\frac{\text{torque} \times \text{r.p.m}}{63025}$ 1 kW = 1.34 HP 1Nm = 8.85 lbf in							

AGRICULTURAL

Polythene covered drive shaft

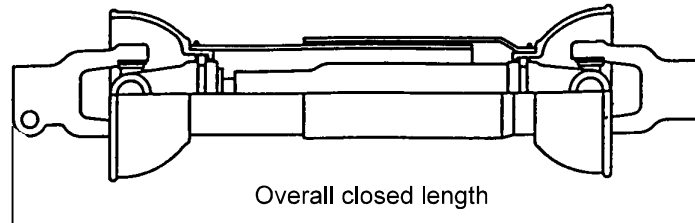

Attention: Universals must be greased every 50 hours use.
Drive shaft telescopic slide to be greased daily.

COMPLETE SHAFTS

Length	Part No.	Notes / Suggestions
Series: 1AG Suits U/J 114.1004 41.3 (1050)	1AGL.02.1050	Shaft unwelded one end
Series: 2AG Suits U/J 401001 59.1 (1500)	2AGL.02.1500	Shaft unwelded one end
Series: 4AG Suits U/J K5LGB36R 59.1 (1500)	4AGL.02.1500	Shaft unwelded one end
Series: 5AG Suits U/J 401003 41.3 (1050)	5AGS.02.1050	Shaft unwelded one end
Series: 8AG Suits U/J 114.5109 47.2 (1200)	8AGS.02.1200	Shaft unwelded one end

Standard shafts are fitted with 1.375 x 6 spline quick release yokes both ends and are fitted with durable polythene safety covers.
Special bored and splined yokes are available.

AGRICULTURAL

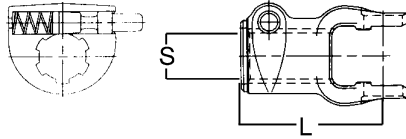

QUICK RELEASE YOKES - SPLINED

Bore S	Length	Part No.	Notes / Suggestions
Series: 1AG 1.375 x 6 (34.9 x 6)	Suits U/J 114.1004 3.35 (85.0)	1YB9.1375	
Series: 2AG 1.375 x 6 (34.9 x 6)	Suits U/J 401001 3.83 (97.5)	2YB9.1375	
Series: 4AG 1.375 x 6 (34.9 x 6)	Suits U/J K5LGB36R 4.29 (109.0)	4YB9.1375	
Series: 5AG 1.375 x 6 (34.9 x 6) 1.750 x 20 (44.5 x 20)	Suits U/J 401003 4.44 (112.7) 4.44 (112.7)	5YB9.1375 5YB9.1750.20	
Series: 8AG 1.375 x 6 (34.9 x 6)	Suits U/J 114.5109 5.04 (128.0)	8YB9.1375	

**Many more quick release yokes available on request.
Please call our sales team if the part you want is not listed.**

AGRICULTURAL

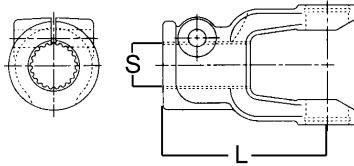

PINCH BOLT YOKES - SPLINED

Bore S	Length	Part No.	Notes / Suggestions
Series: 1AG 1.375 x 6 (34.9 x 6)	Suits U/J 114.1004 3.43 (87.2)	1YB3.1375	
Series: 2AG 1.375 x 6 (34.9 x 6)	Suits U/J 401001 3.86 (98.1)	2YB3.1375	
Series: 4AG 1.375 x 6 (34.9 x 6)	Suits U/J K5LGB36R 4.29 (109.0)	4YB3.1375	
Series: 5AG 1.375 x 6 (34.9 x 6)	Suits U/J 401003 4.49 (114.0)	5YB3.1375	

1

**Many more pinch bolt yokes available on request.
Please call our sales team if the part you want is not listed.**

AGRICULTURAL



PLAIN BORE YOKES – TAPPED FOR SET SCREW

Bore S	Keyway X	Length L	Part No.	Notes / Suggestions
Series: 1AG Suits U/J 114.1004				
.750 (19.1)	0.313 (8.0)		1YM7.0750	.313 Set Screw (8.0)
1.000 (25.4)	0.250 (6.4)	2.46 (62.6)	1YM7.1000	.313 Set Screw (8.0)
Series: 2AG Suits U/J 401001				
1.250 (31.8)	0.375 (9.5)	3.56 (90.5)	2YM7.1250	.375 Set Screw (9.5)
1.375 (25.4)	0.375 (9.5)	3.56 (90.5)	2YM7.1375	.375 Set Screw (9.5)
Series: 4AG Suits U/J K5LGB36R				
1.250 (31.8)	0.375 (9.5)	3.96 (100.5)	4YM7.1250	.375 Set Screw (9.5)
1.375 (34.9)	0.375 (9.5)	3.96 (100.5)	4YM7.1375	.375 Set Screw (9.5)
1.500 (38.1)	0.375 (9.5)	3.96 (100.5)	4YM7.1500	.500 Set Screw (12.7)
Series: 5AG Suits U/J 401003				
1.375 (34.9)	0.375 (9.5)	4.15 (105.5)	5YM7.1375	.375 Set Screw (9.5)
1.500 (38.1)	0.375 (9.5)	4.15 (105.5)	5YM7.1500	.500 Set Screw (12.7)

**Many more plain bore yokes available on request.
Please call our sales team if the part you want is not listed.**

AGRICULTURAL

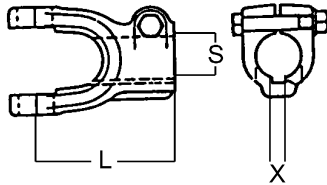

PINCH BOLT YOKES - PLAIN BORE

Bore S	Keyway X	Length L	Part No.	Notes / Suggestions
Series: 4AG	Suits U/J	K5LGB36R		
1.375 (34.9)	0.375 (9.5)	4.31 (109.5)	4YB2.1375	

**Many more plain bore yokes with pinch bolt available on request.
Please call our sales team if the part you want is not listed.**

AGRICULTURAL



Round Tube

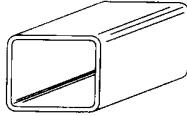

Rectangular Tube

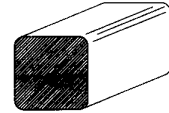
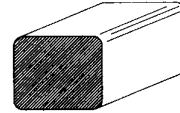

Rectangular and Square Bar

SHAFTING AND TUBING

Dimensions	Sold Per	Series	Use Weld Yoke	Part Number	Notes / Suggestions
Rectangular Tube					
1.000 x 1.125 (25.4 x 28.6)	Per 100mm	0600	15.5131	70.1001	
1.250 x 1.375 (31.8 x 34.9)	Per 100mm	1200 1800 2000	12.1138	70.1250	

Dimensions	Sold Per	Series	Use Weld Yoke	Part Number	Notes / Suggestions
Round Tube					
1.625 x .065 (41.3 x 1.7)	Per 100mm	0600 L600	15.5132	70.1625	Round
2.250 x .120 (57.2 x 3.0)	Per 100mm	2200 CP44R	22.1343	70.2250	Round
2.750 x .109 (57.2 x 2.8)	Per 100mm	CP44R 2600	26.5155	70.2750	Round

Dimensions	Sold Per	Series	Use Weld Yoke	Part Number	Notes / Suggestions
Rectangular Bar					
.750 x .875 (19.1 x 22.2)	Per 100mm	0600 L600	15.5129	73.0750	
1.000 x 1.125 (25.4 x 28.6)	Per 100mm	1200 1800 2000	12.1340	73.1001	

AGRICULTURAL

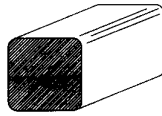
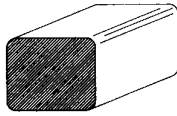

Rectangular and Square Bar

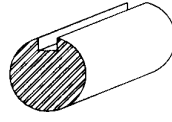

Round

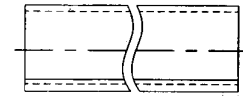
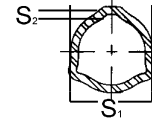

Triangular Inner and Outer Tube Sets

SHAFTING AND TUBING

Dimensions S	Keyway	Sold Per	Part No.	Notes / Suggestions
Solid Bar with full length keyway				
.750 RND (19.1)	0.188 (4.8)	Per 100mm	71.0750	
875 RND (22.2)	0.250 (6.4)	Per 100mm	71.0875	

Dimensions S	Sold Per	Part No.	Notes / Suggestions
Square Solid Bar			
1.188 SQ (30.2)	Per 100mm	73.1188	
1.313 SQ (33.4)	Per 100mm	73.1313	

Dimensions S1 S2	Sold Per	Part No.	Notes / Suggestions
Triangular Inner and Outer Tube Set			
1.141 x .156 (29.0 x 4.0)	Per 100mm	70.0205	Inner
1.422 x .125 (36.0 x 3.2)	Per 100mm	70.0305	Outer
Triangular Inner and Outer Tube Set			
1.422 x .125 (36.0 x 3.2)	Per 100mm	70.0305	Inner
1.688 x .141 (42.9 x 3.6)	Per 100mm	70.0304	Outer

AGRICULTURAL

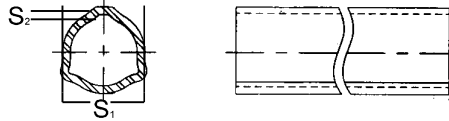

Triangular Inner and Outer Tube Sets

SHAFTING AND TUBING

Dimensions S1 S2	Sold Per	Part No.	Notes / Suggestions
Triangular Inner and Outer Tube Set			
1.422 x .172 (36.0 x 4.4)	Per 100mm	70.0405	Inner
1.688 x .141 (42.9 x 3.6)	Per 100mm	70.0304	Outer
Triangular Inner and Outer Tube Set			
1.781 x .156 (45.2 x 4.0)	Per 100mm	70.0505	Inner
2.031 x .125 (51.6 x 3.2)	Per 100mm	70.0504	Outer
Triangular Inner and Outer Tube Set			
1.750 x .156 (45.0 x 4.0)	Per 100mm	70.0505	Inner
2.125 x .156 (54.0 x 4.0)	Per 100mm	70.0704	Outer
Triangular Inner and Outer Tube Set			
1.750 x .212 (44.4 x 5.5)	Per 100mm	70.0705	Inner
2.125 x .156 (54.0 x 4.0)	Per 100mm	70.0704	Outer
Triangular Inner and Outer Tube Set			
2.125 x .156 (54.0 x 4.0)	Per 100mm	70.0704	Inner
2.500 x .156 (64.0 x 4.0)	Per 100mm	70.0804	Outer

1

AGRICULTURAL

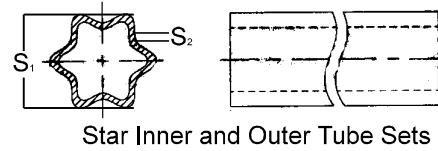
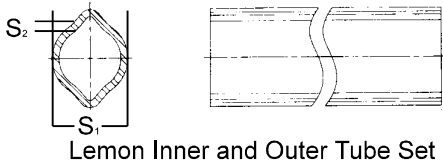

SHAFTING AND TUBING

Dimensions S1 S2	Sold Per	Part No.	Notes / Suggestions
Lemon Inner and Outer Tube Set			
.922 x .141 (23.5 x 3.6)	Per 100mm	70.2105	Inner
1.188 x .110 (30.2 x 2.8)	Per 100mm	70.2104	Outer
Lemon Inner and Outer Tube Set			
1.360 x .156 (34.5 x 4.0)	Per 100mm	70.2205	Inner
1.625 x .110 (41.3 x 2.8)	Per 100mm	70.2204	Outer
Lemon Inner and Outer Tube Set			
1.563 x .172 (39.7 x 4.4)	Per 100mm	70.2405	Inner
1.891 x .156 (48.0 x 4.0)	Per 100mm	70.2404	Outer

1

Dimensions S1 S2	Sold Per	Part No.	Notes / Suggestions
Star Inner and Outer Tube Sets			
2.000 (50.8)	Per 100mm	70.2505	Inner
2.410 x .172 (61.0 x 4.4)	Per 100mm	70.2504	Outer

1

PTO

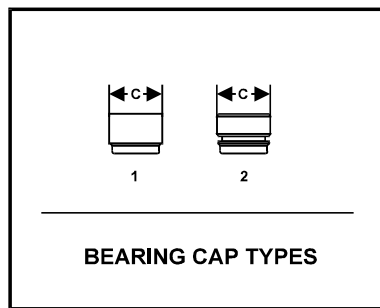
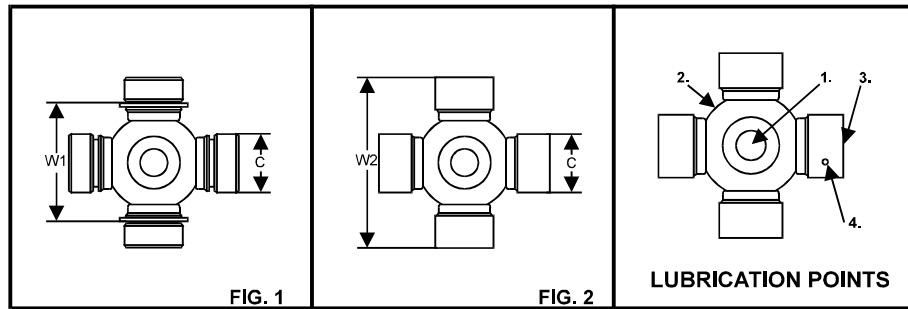

UNIVERSAL JOINT DIMENSIONAL DATA.

DIA C	INT W1	EXT W2	CAPS			PART No.	LUBE	SERIES
			QTY	TYPE	FIG			
22		54	4	1	2	K5A588	1	BYPY PTO
22		55	4	1	2	K5A589	1	WALTERSCHEID PTO
23.8	37.7		4	2	1	0675X	1	0600 SERIES
23.8	37.7		4	2	1	0675X.1A	3	0600 SERIES
23.8	38.1		4	2	1	5.170X	1	1000 SERIES
23.8		62	4	1	2	K5A64	1	1140 SERIES PTO
24.6	36.8		4	2	1	114.1004	1	L6N SERIES
25.4	46.8		4	2	1	401001	1	2AG SERIES
25.4	59.53		4	2	1	114.2101	2	2R SERIES
26.9	46.04		4	2	1	RUJ1788	1	1200 SERIES
26.99		74.61	4	1	2	K5LGB36R	1	1300 SERIES PTO
27		70	4	1	2	K5A590	1	WALTERSCHEID PTO
28.58		66.67	4	1	2	CPL14N	1	2000 SERIES
28.58		66.67	4	1	2	CPL14N.1A	3	2000 SERIES
30.16		92.08	4	1	2	K5A18R	1	1350 SERIES PTO
30.2		80	4	1	2	K5A591	1	BYPY PTO
31.75		81.36	4	1	2	CP35N	1	2200 SERIES
32		76	4	1	2	K5A592	1	WALTERSCHEID
33.35	70.64		4	2	1	CP44R	2	ROCKWELL PTO
33.35	84.15		4	2	1	114.5109	2	8AG SERIES
34.93		106.38	4	1	2	K5A538	1	1480 SERIES PTO
36		89	4	1	2	K5A593	1	WALTERSCHEID
38.89		109.6	4	1	2	CP55N	2	

PTO

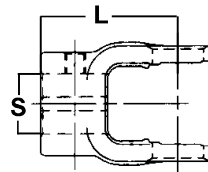
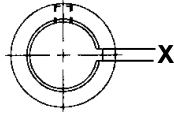

PLAIN BORE YOKES – TAPPED FOR SET SCREW

Bore S	Keyway X	Length L	Part No.	Notes / Suggestions
SERIES: 0600		Suits U/J 0675X		
Blank	-	2.50 (63.5)	15.0500A	Forged blank yoke
-	-			
0.625 (15.9)	0.188 (4.8)	2.50 (63.5)	15.5336	
0.750 (19.1)	0.188 (4.8)	2.50 (63.5)	15.5111	
0.875 (22.2)	0.250 (6.4)	2.50 (63.5)	15.5113	
0.875 (22.2)	-	2.50 (63.5)	15.05105	Blank requires forging.
1.000 (25.4)	0.250 (6.4)	2.50 (63.5)	15.5115	
1.062 (26.9)	0.250 (6.4)	2.50 (63.5)	15.5191	
1.125 (28.6)	0.313 (7.9)	2.50 (63.5)	15.5116	
1.250 (31.8)	0.313 (7.9)	2.50 (63.5)	15.5118	
1.250 (31.8)	0.250 (6.4)	2.50 (63.5)	15.5335	
1.375 (34.9)	0.313 (7.9)	2.50 (63.5)	15.5374	
SERIES: 1000		Suits U/J 5.170X		
0.750 (19.1)	0.188 (4.8)	2.50 (63.5)	10.4.13	
0.875 (22.2)	0.250 (6.4)	2.50 (63.5)	10.4.63	
1.000 (25.4)	0.250 (6.4)	2.50 (63.5)	10.4.573	
1.125 (28.6)	0.250 (6.4)	2.50 (63.5)	10.4.143	
1.125 (28.6)	0.313 (7.9)	2.50 (63.5)	10.4.113	
1.250 (31.8)	0.313 (7.9)	2.50 (63.5)	10.4.193	

PTO

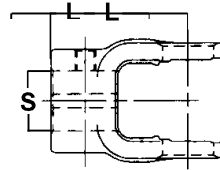
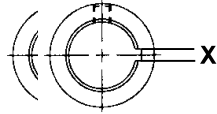

PLAIN BORE YOKES – TAPPED FOR SET SCREW

Bore S	Keyway X	Length L	Part No.	Notes / Suggestions
SERIES: 1200		Suits U/J RUJ1788		
Blank	-	3.62 (91.9)	12.1100AH	Blank forged yoke
.750 (19.1)	0.187 (4.7)		12.1312	
.875 (22.2)	0.250 (6.4)	2.75 (69.9)	12.1133	
1.000 (25.4)	0.250 (6.4)	2.75 (69.9)	12.1135	
1.250 (31.8)	0.313 (7.9)	2.75 (69.9)	12.1139	
1.250 (31.8)	0.313 (7.9)	5.25 (133.4)	12.1174	
1.250 (31.8)	0.313 (7.9)	3.50 (88.9)	12.1119	
1.375 (34.9)	0.313 (7.9)	3.50 (63.5)	12.1120	
1.500 (38.1)	0.375 (9.5)	2.75 (69.9)	12.1175	
SERIES: 1800		Suits U/J 114.2101		
1.000 (25.4)	0.250 (6.4)	3.75 (95.3)	18.7115	
1.250 (31.8)	0.313 (7.9)	3.75 (95.3)	18.7119	
SERIES: 2000		Suits U/J CPL14N		
1.000 (25.4)	0.250 (6.4)	3.75 (95.3)	20.9115	
1.125 (28.6)	0.313 (7.9)	3.75 (95.3)	20.9117	
1.188 (30.2)	0.313 (7.9)	3.75 (95.3)	20.9118	
1.250 (31.8)	0.313 (7.9)	3.75 (95.3)	20.9119	

CONTINUED NEXT PAGE

PTO



PLAIN BORE YOKES – TAPPED FOR SET SCREW

Bore S	Keyway X	Length L	Part No.	Notes / Suggestions
SERIES: 2000 Suits U/J CPL14N				
1.375 (31.8)	0.313 (7.9)	3.75 (95.3)	20.9120	
1.500 (38.1)	0.375 (9.5)	3.75 (95.3)	20.9307	
SERIES: 2200 Suits U/J CP35N / CP35N.1A				
1.250 (31.8)	0.313 (7.9)	4.18 (106.4)	22.1116	
1.500 (38.1)	0.375 (9.5)	4.18 (106.4)	22.1120	
SERIES: 2600 Suits U/J K5A538				
1.500 (31.8)	0.375 (9.5)	4.50 (114.3)	26.5119	
1.750 (44.5)	0.375 (9.5)	4.06 (103.2)	26.5131	
SERIES: 55N SERIES Suits U/J CP55N				
1.500 (38.1)	0.375 (9.5)	4.06 (103.2)	55.2410	
1.750 (44.5)	0.375 (9.5)	4.06 (103.2)	55.2800	
2.000 (50.8)	0.500 (12.7)	5.56 (141.3)	55.3240	

PTO

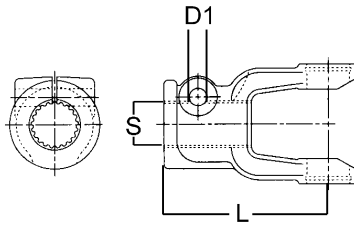

PINCH BOLT YOKES

Bore S	Bolt Fit D1	Length L	Part No.	Notes / Suggestions
SERIES: 0600 Suits U/J 0675X				
.734 x 16 (18.7 x 16)	.438 (11.1)	2.75 (69.9)	15.5352	
SERIES: 2200 Suits U/J CP35N CP35N.1A				
1.375 x 6 (34.9 x 6)	.313 (7.9)	4.75 (120.7)	22.1140	
1.375 x 21 (34.9 x 21)	.500 (12.7)	4.75 (120.7)	22.1105	
SERIES: 55N Suits U/J CP55N				
1.750 x 20 (44.5 x 20)	.625 (15.9)	5.13 (130.2)	55.2836	

PTO



QUICK RELEASE YOKES - SPLINED

Bore S	Length L	Pin Repair Kit Part No.	Part No.	Notes / Suggestions
SERIES: 0600		Suits U/J 0675X		
1.375 x 21 (34.9 x 21)	3.563 (90.5)	56.1857	15.5411	Pin type
1.375 x 6 (34.9 x 6)	3.563 (90.5)	56.1857	15.5101	Pin type
SERIES: 1200		Suits U/J RUJ1788		
1.375 x 6 (34.9 x 21)	4.063 (103.2)	56.1857	12.1101	Pin type
1.375 x 21 (34.9 x 21)	4.063 (103.2)	56.1857	12.1193	Pin type
SERIES: 1800		Suits U/J 114.2101		
1.375 x 6 (34.9 x 6)	4.250 (108.0)	56.1857	18.7403	Pin type
1.375 x 21 (34.9 x 21)	4.250 (108.0)	56.1857	18.7406	Pin type
SERIES: 2000		Suits U/J CPL14N		
1.375 x 6 (34.9 x 6)	4.250 (108.0)	56.1857	20.9309	Pin type
1.375 x 21 (34.9 x 21)	4.250 (108.0)	56.1857	20.9325	Pin type
SERIES: 2200		Suits U/J CP35N CP35N.1A		
1.375 x 21 (34.9 x 21)	4.813 (122.3)	56.1857	22.2317	Pin type

PTO



QUICK RELEASE YOKES – SPLINED

Bore S	Length L	Pin Repair Kit Part No.	Part No.	Notes / Suggestions
SERIES: 2600		Suits U/J K5A538		
1.375 x 6 (34.9 x 6)	5.250 (133.4)	56.1857	26.5321	Pin type
1.375 x 21 (34.9 x 21)	5.063 (128.6)	56.1857	26.5319	Pin type
1.750 x 20 (44.5 x 20)	6.000 (152.4)	56.2669	26.5163	Collar type
SERIES: 55N		Suits U/J CP55N		
1.375 x 6 (34.9 x 6)	5.813 (147.6)	56.1857	55.9306	Pin type
1.375 x 21 (34.9 x 21)	5.813 (147.6)	56.1857	55.9321	Pin type
1.750 x 20 (44.5 x 20)	6.375 (161.9)	56.2446	55.9320	Pin type

PTO

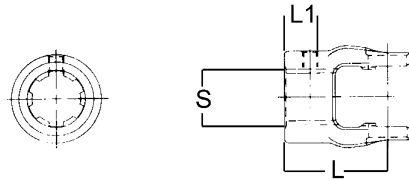

SPLINED YOKES – TAPPED FOR SET SCREW

Bore S	Length L	LTH L1	Part No.	Notes / Suggestions
SERIES: 0600 Suits U/J 0675X				
.875 x 13 (22.2 x 13)	2.500 (63.5)	-	15.5334	
1.000 x 6 (25.4 x 6)	2.500 (63.5)	-	15.5158	
1.000 x 15 (25.4 x 6)	2.000 (50.8)	-	15.051UV	Limited quantities
1.125 x 6 (28.6 x 6)	2.500 (63.5)	.625 (15.9)	15.5134	
1.250 x 14 (28.6 x 6)	2.500 (63.5)	-	15.051V1	
1.375 x 6 (34.9 x 6)	2.500 (63.5)	.375 (9.5)	15.5187	
SERIES: 1000 Suits U/J 5.170X				
.875 x 13 (22.2 x 13)	2.500 (63.5)	.625 (15.9)	10.4.481	
SERIES: 1200 Suits U/J RUJ1788				
1.000 x 15 (25.4 x 15)	3.500 (88.9)	.750 (19.1)	12.111CU	
1.125 x 6 (28.6 x 6)	3.500 (88.9)	1.250 (31.8)	12.1181	
1.375 x 6 (34.9 x 6)	3.500 (88.9)	.938 (23.8)	12.1172	
SERIES: 2000 Suits U/J CPL14N				
1.375 x 6 (34.9 x 6)	3.750 (95.3)	.938 (23.8)	20.9132	
SERIES: 2200 Suits U/J CP35N CP35N.1A				
1.375 x 6 (34.9 x 6)	4.188 (106.4)	1.250 (31.8)	22.1134	

PTO



SPECIAL YOKES

Bore S	Length L	LTH L1	Part No.	Notes / Suggestions
SERIES: 0600		Suits U/J 0675X		
1.125 (28.6)	2.500 (63.5)		15.5138	Square
SERIES: 1200		Suits U/J RUJ1788		
1.000 (25.4)	2.750 (69.9)	.625 (15.9)	12.1159	Square
1.375 (34.9)	3.250 (82.6)	.500 (12.7)	12.1320	Shear
SERIES: 2000		Suits U/J RUJ1788		
1.250 (31.8)	3.750 (95.3)	.875 (22.2)	20.9218	Round-Double Keyway .250 .313 (6.4) (8.0)
SERIES: 2200		Suits U/J CP35N CP35N.1A		
1.250 (31.8)	4.188 (106.4)	.875 (22.2)	22.1218	Round-Double Keyway .250 .313 (6.4) (8.0)
1.375 (34.9)	4.188 (106.4)	.875 (22.2)	22.1219	Round-Double Keyway .313 .375 (8.0) (9.5)

PTO

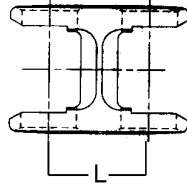

DOUBLE PIVOT YOKES

Length L	Max Operating Angle	Part No.	Notes / Suggestions
SERIES: 0600	Suits U/J 0675X		
1.688 (42.9)	5°	10.5303	
2.500 (63.5)	18°	10.5361	(15.5361)
3.188 (81.0)	45°	10.5331	(15.5331)
SERIES: 1200	Suits RUJ1788		
3.375 (85.7)	35°	12.1356	

PTO

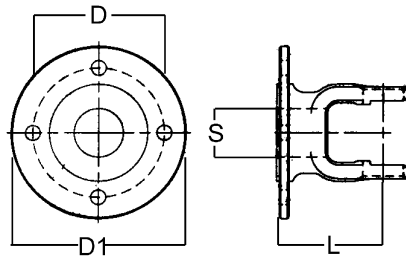

FLANGE YOKES

Bore S	Length L	Flange Type (D1)	Bolt Circle (D)	Hole Dia	No. of Holes	Part Number
SERIES: 0600		Suits U/J 0675X				
2.250 (57.2)	1.610 (40.9)	RND 3.500 (88.9)	2.750 (69.9)	.344 (8.7)	4	46.6902
-	2.626 (66.7)	RND 4.126 (104.8)	-	-	-	15.0500Y4C Blank cast flange semi-finished

PTO

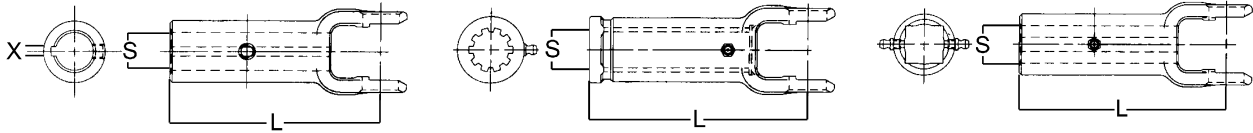

SLIP YOKES

Bore S	Length L	Keyway X	Distance to End	Part Number	Notes / Suggestions
SERIES: 0600 Suits U/J 0675X					
Blank	5.500 (139.7)	-	-	15.0500C	Forged blank yoke
.750 RND (19.1)	5.500 (139.7)	.188 (4.8)	2.000 (50.8)	15.5183	Round
.875 RND (22.2)	5.500 (139.7)	.250 (6.4)	2.000 (50.8)	15.5184	Round
1.125 x 10 (28.6 x 10)	5.500 (139.7)	-	3.500 (88.9)	15.5275	Spline
1.250 x 6 (31.8 x 6)	5.500 (139.7)	-	2.000 (50.8)	15.5169	Spline
1.000 SQ (25.4)	5.500 (139.7)	-	2.000 (50.8)	15.5305	Square
SERIES: 1000 Suits U/J 5.170X					
.875 RND (22.2)	5.500 (139.7)	.250 (6.4)	1.750 (44.5)	10.3.33X	Round
SERIES: 1200 Suits U/J RUJ1788					
2.000 Solid (50.8)	5.250 (133.4)	-	-	12.1100C	Solid forged.
1.250 x 6 (31.8)	5.250 (133.4)	-	1.750 (44.5)	12.1171	Spline
1.375 x 16 (34.9)	5.250 (133.4)	-	3.375 (85.7)	12.2322	Spline

PTO

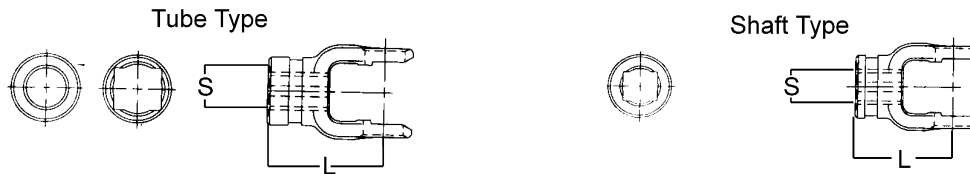

WELD YOKES

Bore S	Length L	Tube Use	Suits Tube	Part Number	Notes / Suggestions
SERIES: 0600					
Suits U/J 0675X					
.750 x .875 (19.1 x 22.2)	2.500 (63.5)	.750 x .875 (19.1 x 22.2)	73.0750	10.4.5129	Shaft Type
1.000 x 1.125 (25.4 x 28.6)	2.750 (69.9)	1.000 x 1.125 (25.4 x 28.6)	70.1001	10.5131	Tube Type RECT
1.188 RND (30.2)	3.000 (76.2)	1.625 x .065 (41.3 x 1.65)	70.1625	10.5132	Tube Type RND
1.250 RND (31.8)	2.500 (63.5)	1.250 x .095 (31.8 x 2.41)	-	10.5174	Tube Type RND
SERIES: 1200					
Suits U/J RUJ1788					
1.843 Solid (46.8)	2.875 (73.0)	2.000 x .083 (50.8 x 2.11)	-	12.111F6	Solid Butt. Tube Type Round
1.000 x 1.125 (25.4 x 28.6)	2.938 (74.6)	1.000 x 1.125 (25.4 x 28.6)	73.1001	12.1340	Shaft Type
1.281 x 1.406 (32.5 x 35.7)	2.938 (74.6)	1.250 x 1.375 (31.8 x 34.9)	70.1250	12.1318	Tube Type RECT
1.500 RND (38.1)	3.750 (95.3)	2.000 x .083 (50.8 x 2.11)	-	12.1334	Tube Type RND
SERIES: 1800					
Suits U/J 114.2101					
1.000 x 1.125 (25.4 x 28.6)	3.375 (85.7)	1.000 x 1.125 (25.4 x 28.6)	73.1001	18.7327	Shaft Type
1.281 x 1.406 (32.5 x 35.7)	3.375 (85.7)	1.250 x 1.375 (31.8 x 34.9)	70.1250	18.7328	Tube Type RECT
1.500 RND (38.1)	3.500 (88.9)	2.000 x .083 (50.8 x 2.11)	-	18.7305	Tube Type RND
SERIES: 2000					
Suits U/J CPL14N					
1.000 x 1.125 (25.4 x 28.6)	3.188 (80.9)	1.000 x 1.125 (25.4 x 28.6)	73.1001	20.9126	Shaft Type
1.500 RND (38.1)	4.000 (101.6)	2.000 x .083 (50.8 x 2.11)	-	20.9131	Tube Type RND

PTO

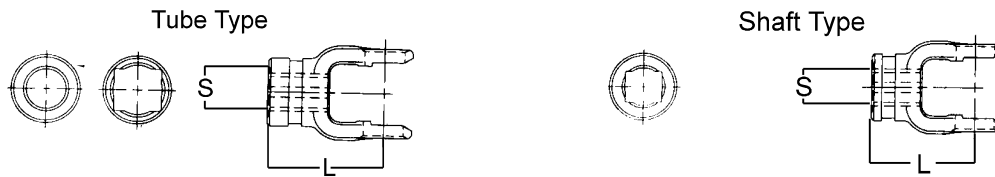

WELD YOKES

Bore S	Length L	Tube Use	Suits Tube	Part Number	Notes / Suggestions
SERIES: 2200					
Suits U/J CP35N CP35N.1A					
1.188 SQ (30.2)	3.625 (92.1)	-	73.1188	22.1344	Shaft Type SQ
1.625 RND (41.3)	4.500 (114.3)	2.250 x .120 (57.2 x 3.0)	70.2250	22.1343	Tube Type RND
SERIES: 2600					
Suits U/J K5A538					
1.313 SQ (33.4)	4.625 (117.5)		73.1313	26.5148	Shaft Type SQ
2.000 RND (50.8)	5.250 (133.4)	2.750 x .109 (69.9 x 2.77)	73.2750	26.5155	TubeType RND
SERIES: 55N					
Suits U/J CP55N					
1.313 SQ (33.4)	4.500 (114.3)	-	73.1313	55.2130	Shaft Type SQ
SOLID BUTT	4.750 (120.7)	2.500 x .125 (63.5 x 3.2)		55.3640	Tube Type SOLID

PTO

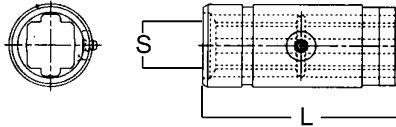

DRIVE NIBS

Spline S	Length L	Tube Use	Tube Part Number	Tube Part Number	Notes / Suggestions
SERIES: 0600	Suits U/J 0675X				
.750 x .875 (19.1 x 22.2)	3.625 (92.1)	1.625 x .065 (41.3 x 1.65)	70.1625	53.0600	
SERIES: 1200 1800 2000	Suits U/J RUJ1788				
1.000 x 1.125 (25.4 x 29.6)	5.000 (127.0)	2.000 x .083 (50.8 x 2.11)	-	53.2034	
SERIES: 2200	Suits U/J CP35N CP35N.1A				
1.188 SQ (30.2)	5.000 (127.0)	2.250 x .120 (57.2 x 3.00)	70.2250	53.2434	
SERIES: 44 2600	Suits U/J CP44R				
1.313 (33.4)	5.000 (127.0)	2.750 x .109 (69.9 x 2.77)	70.2750	53.2644	
SERIES: MISC					
1.625 (41.3)	6.000 (152.4)	2.250 x .120 (57.2 x 3.00)	70.2250	53.2415	Limited quantities

PTO

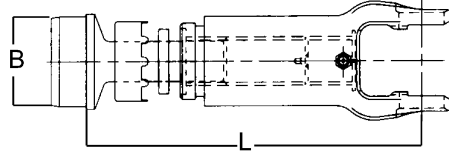

SLIP AND STUB ASSEMBLIES

Spline S	Weld-Centre Compressed	Weld-Centre Extended	Butt B	Part Number	Notes / Suggestions
SERIES: 0600	Suits U/J 0675X				
1.125 x 10 (28.6 x 10)	6.060 (153.9)	7.812 (198.4)	1.063 (27.0)	51.5275	
SERIES: 1200	Suits U/J RUJ1788				
1.375 x 16 (34.9 x 16)	5.875 (149.2)	7.375 (187.3)	1.843 (46.8)	51.2322	

PTO

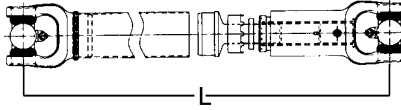

UNWELDED DRIVESHAFTS

Max Length L	Part Number	Notes / Suggestions
SERIES: 0600	Suits U/J 0675X	
36.000 (914.4)	58.0627	Complete with plastic cover
43.875 (1114.4)	63.0642	
67.875 (1724.0)	63.0666	
SERIES: 1000	Suits U/J 5.170X	
54.125 (1374.8)	11.2701	
66.125 (1679.6)	11.2702	
SERIES: 1200	Suits U/J RUJ1788	
55.250 (1403.4)	63.1254	
67.250 (1708.2)	63.1266	
SERIES: 2000	Suits U/J CPL14N	
60.000 (1524.0)	58.2052	Complete with plastic cover.
SERIES: 2200	Suits U/J CP35N CP35N.1A	
60.000 (1524.0)	58.2251	Complete with plastic cover.

PTO

Woodruff Key

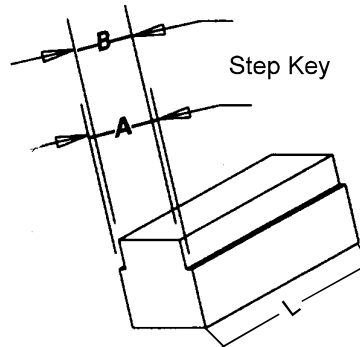
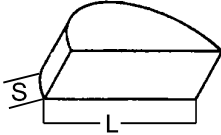

Square Key

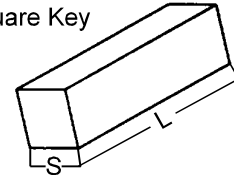

KEYS

Width S	Length L	Woodruff Part No.	Part No.	Notes / Suggestions
Woodruff Keys				
.188 (4.8)	1.000 (25.4)	13	K1504	
.250 (6.4)	1.000 (25.4)	15	K1505	
.313 (7.9)	1.000 (25.4)	B	K1506	

A	B	Length	Part No.	Notes / Suggestions
Step Keys				
.313 (7.9)	.250 (6.4)	1.250 (31.8)	K1511	
.250 (6.4)	.188 (4.8)	1.250 (31.8)	K1512	
.375 (9.5)	.313 (7.9)	1.500 (38.1)	K1513	

Width S	Length L	Part No.	Notes / Suggestions
Square Keys			
.188 x .188 (4.8 x 4.8)	1.000 (25.4)	K1501	
.250 x .250 (6.4 x 6.4)	1.000 (25.4)	K1502	
.313 x .313 (7.9 x 7.9)	1.000 (25.4)	K1503	

PTO

Square Type Head

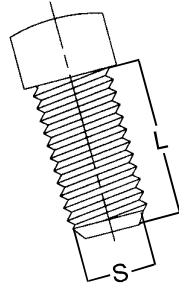

Allen Head Type

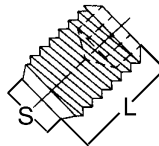

SET SCREWS

Diameter	Length L	Head	Point	Part Number	Notes / Suggestions
Set Screws					
.375 x 16 (9.5 x 16)	.500 (12.7)	Allen	Cup	50.2501	
375 x 16 (9.5 x 16)	.750 (19.1)	Square	Cup	50.2502	
.250 x 20 (6.4 x 20)	.500 (12.7)	Allen	Cup	50.2503	